



*A robust and modular solution for creating seamless displays with phenomenal brightness and contrast that can withstand harsh outdoor conditions*

## Outdoor DV-LED Displays

P4 | P6

With unparalleled flexibility and limitless creativity, DV-LED offers immersive experiences that are impossible to ignore. In today's bustling world, it's all about the power of visual impact, as businesses must embrace innovative ways to captivate audiences and make their messages stand out. As a versatile tool, Direct View LED unlocks the potential for truly captivating visuals, ensuring your messages always make a statement.

### Outdoor DV-LED Highlights

- Ultra High Brightness (6,500/8,000 cd/m<sup>2</sup>)
- IP Rated Weatherproof Design
- Front or Rear Serviceability
- Easy Installation Cabinet Design
- End to End Project Management



# Main Features

## End-to-End Project Management

We understand that every Direct View LED project is unique and each comes with their own set of challenges. In order to help our partners embrace this innovative technology, we are offering full end-to-end project management. From design to installation, our team is dedicated to assisting you every step of the way.

Bespoke displays can be developed to accommodate specific project requirements, installation of the Video Walls can be carried out or assisted by team members to ensure a hassle-free process, and maintenance can be provided when necessary. This all guarantees easy accessibility to the solutions for both you and your customers.

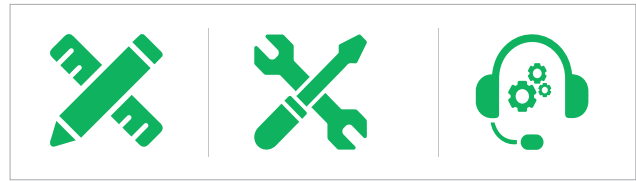

Design >> Installation >> Maintenance

## Outdoor Reliability

This display includes a variety of features and services that were designed to maximise the lifespan of your displays, ensuring the high quality and consistency of our solutions.



3 Year Warranty



24/7 Usage



Long Lifespan

## Simple to Setup

### Lightweight and Slim Cabinets

Each cabinet is lightweight and slim, making these screens much easier to install. The lighter weight also reduces stress on the mounting structure.



Per Cabinet



## Outstanding High Brightness

With impressive brightness levels, the DV-LED Video Wall has outstanding visibility. The display is sunlight readable even in direct sunlight, instantly catching attention from viewers and ensuring your content always stands out.



P4: 6,500cd/m<sup>2</sup>

P6: 8,000cd/m<sup>2</sup>

## Easy Installation

The light and compact design as well as prefixed modules, positioning pins and simple cabinet structure make this display ideal for either permanent installations or rental jobs. Each cabinet also has integrated cable management to keep things tidy for a clean finish.



## User Friendly Maintenance

Through an intuitive and easy-to-use system, the DV-LED Displays can be serviced from either the front or the rear of the cabinets. When maintenance is required, either side of the cabinets can be used to access the components quickly and efficiently without disruption.



Front or Rear Maintenance



## Remote Updates from the Cloud

Take full control of your DV-LED Display's content with our CMS system. Publish and monitor your content from anywhere in the world via our online portal and ensure relevant messages are being displayed. We can help provide you with easy-to-use templates that allow you to update your content in seconds.



## Other Features

### Stunning Image Quality

State of the art SMD-LED technology that delivers remarkable image quality across the seamless display, certain to garner attention. With advanced video processing technology to produce accurate and vibrant colours with no distortion, offering remarkable viewing experiences.



### IP Rated Weatherproof Enclosure

Designed with a robust aluminium enclosure to protect the display from harsh weather conditions, the outer casing is also IP-rated, keeping out airborne swarf, dust and other particles.

**IP65**  
Front/Back

Dust Resistance	
6	Protected against dust that may harm equipment.
Water Resistance	
5	Protected against water spray from all directions.



### High Refresh Rate

With a refresh rate more than three times higher than the industry standard, every image and video will come to life with astonishing clarity and precision, delivering a captivating visual experience with fluid transitions.



<1,000Hz

Conventional Outdoor DV-LED Video Wall



>3,750Hz

Outdoor DV-LED Video Wall

### Ultra-wide Viewing Angle

Featuring an ultra-wide viewing angle of up to 140°, this solution ensures an unparalleled viewing experience with vibrant colours, sharp contrast and incredible detail.



120°



140°



140°



120°

### Complete Quality Control

From production to installation, we conduct multiple strict quality control procedures to ensure the reliability and functionality of the display. Quality calibrations are also carried out in order to achieve the best consistent and vibrant images across the entire Video Wall.

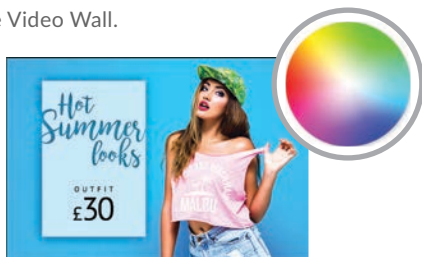

### Ultra High Contrast Ratio

With a remarkable ultra-high contrast ratio, the DV-LED Video Walls deliver deeper blacks, vivid colours and clear visibility across the display without sacrificing brightness, offering a truly immersive and enhanced viewing experience.



DV-LED Outdoor Video Wall



Conventional DV-LED Video Wall

## Real Life Applications

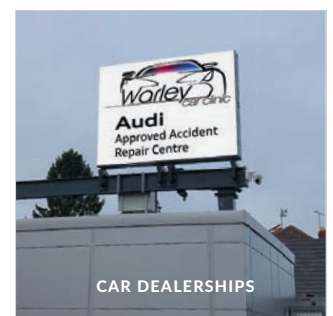
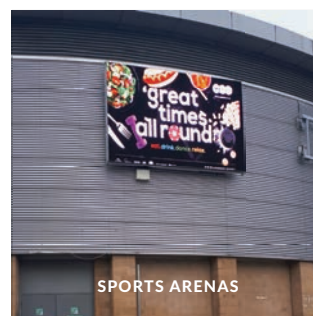
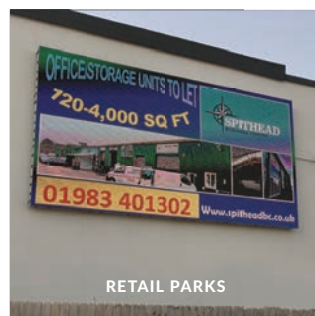

# Specification Table

		P4	P6
LED Display	Pixel Pitch (mm)	4.0mm	6.67mm
	LED Type	SMD 1921	SMD 2727
	Pixel configuration	1R1G1B	
	Brightness (cd/m <sup>2</sup> )	6,500	8,000
	Refresh rate	3840Hz	
	Contrast Ratio	10,000:1	15,000:1
	Viewing angle - Horizontal	140°	
	Viewing angle - Vertical	120°	
	Processing	20 bit	
	Frame rate	60 fps	
	Maintenance	Front & Rear Access	
Cabinet	Cabinet Size (mm)	960x960x68	
	Cabinet Resolution (px)	240x240	144x144
	Net Weight (Kg)	20.5	
Power	Input Voltage	AC100~240V@ 50/60Hz	
	Average Power Consumption (Per Cabinet)	160W	193W
	Maximum Power Consumption (Per Cabinet)	480W	580W
Environmental	IP Rating - Front	IP65	
	IP Rating - Rear	IP65	
	Operating Temperature	-20°C to +50°C	
	Operating Humidity	10% to 95%	
	Lifetime	100,000 hours	
Warranty	Warranty Period	3 Year Warranty	
	Technical Support	Lifetime	

# Technical Drawing

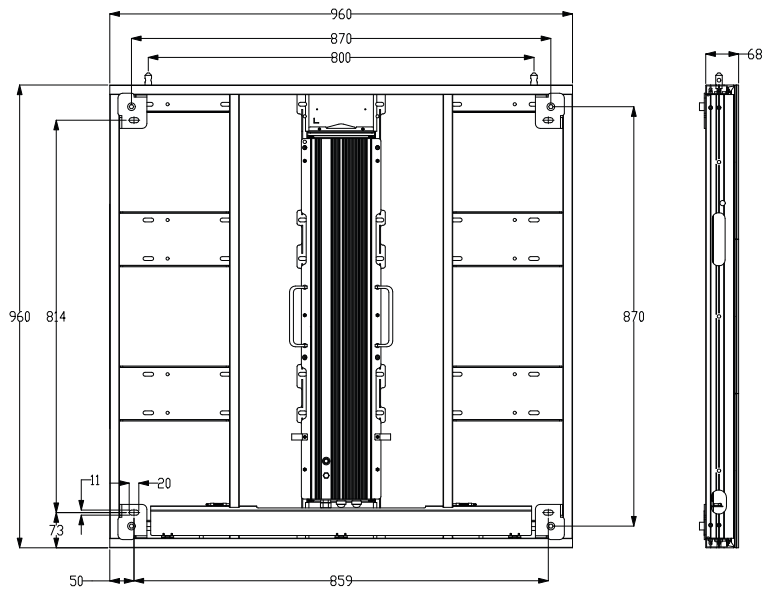

# Why Choose Our Commercial Display Solutions?



## Lifetime Technical Support

From the moment you receive your product, throughout the duration of your warranty and even after your warranty has expired we are here to support you. If you require any assistance setting up or using your product, or have any problems at all, we can provide free technical support via telephone and email.

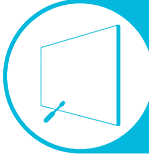

## On-site Support and Maintenance\*

If needed, we can provide an installation service for any of our products. We can also set up service-level agreements for larger projects that require maintenance contracts.



## Extended Warranty\*

All of our commercial display products come with a 3 year commercial warranty as standard but if you want to extend this you can upgrade this to cover a 5 year period at point of purchase.



## Training

As well as providing free remote CMS training sessions and webinars we can also visit you to deliver bespoke training for our software and hardware\*.



## Advanced Replacements†

Should your display suffer from any kind of hardware failure during the warranty period we will send you an advanced replacement and arrange for your old display to be collected, free of charge. This ensures no downtime where you are without a screen.



## Custom Product Testing & Configuration

If you need us to test third party software or a website, or configure your screen in a particular way before it is dispatched (e.g. in a particular orientation or network mode), we can do so to make your life easier.



## 3D Rendering

Want to know how a particular screen will look once installed? Send us a photo of the location and we will create a 3D rendering of any screen in situ to help you to visualise how amazing it will look.



## Logistics Support

We hold more stock in our UK warehouse than any other manufacturer so we can help you meet tight deadlines. For last minute orders we can also offer special express or morning delivery options\*. We also carry out UK based quality control checks on every display before it leaves our warehouse.



## Project Support

If you need to loan a sample unit to test we'd be more than happy to arrange this. We can also provide a rental service for temporary projects\*.



## Customisation\*

Your display can be customised to suit your requirements by adding your logo or printed graphics or even tailoring the colour of a display. We can also carry out hardware modifications to existing products or manufacture bespoke solutions for special projects.



## Extras\*

As well as being able to provide accessories and add-ons, such as extra remote controls, NUC PCs and video wall controllers, we can also supply custom made flight cases which are great if a display needs to be moved safely from place to place.

†UK mainland only

\*These particular services may incur additional charges