

43" Network Digital Menu Boards



Cost-effective package solution; 24/7 commercial grade displays with built-in network media player and 1 year CMS software subscription

Complete Package Solution

We have combined a 24/7 commercial display, a network Android media player, one year free CMS software and a library of pre-designed templates for the ultimate package solution.



1st Year Free Software Subscription

The first year of using our cloud based CMS is absolutely free. You can also purchase 3 additional year's access at the point of purchase or make a one off payment to have access for life.





 Integrated Android Media Player

 Update Over the Internet

 Narrow Bezel

 450cd/m² Brightness

 Exclusive Template Library

 24/7 Commercial Grade

 Landscape or Portrait

 Commercial Grade IPS Panel

 3-Year Warranty

 Lifetime Technical Support

Other Features

24/7 Commercial Use

These displays use a commercial grade LCD panel and LED backlight. They have the ability to be in constant use 24/7 for over 70,000 hours and have no external buttons or controls to avoid tampering.



Exclusive Template Library

As well as being able to create your own layouts you can choose from our exclusive library of pre-design editable templates. Choose an existing layout, add your own images and information then publish it to your screen.



450cd/m² IPS Panel

Commercial grade IPS technology accurately displays image quality and colour depth with no fall-off in colour accuracy. These panels are designed to achieve ultimate lifelike colour temperature when used in either landscape or portrait.



Update Instantly From Anywhere

No special software installation or dedicated PC is required, simply login to our online your portal and update your screens from anywhere in the world with an internet connection.



Multi Screen Synchronisation

Create stunning content across multiple displays or just have your menus change at the same time.



Narrow Bezel

The slim border on the Digital Menu Boards allows your menu to take centre stage especially when multiple displays are placed side by side.



Power Timer

The eco-friendly power timer allows you to assign daily or weekly on and off times for your screen meaning that it is only in use when it needs to be; improving your environmental efficiency.



Plug and Play Backup

If you lose your internet connection you can still update the screen using a USB stick to keep things simple.



Key Features

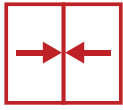

NARROW BEZEL



INTEGRATED ANDROID MEDIA PLAYER



IPS PANEL



24/7 COMMERCIAL GRADE



LANDSCAPE OR PORTRAIT ORIENTATION

INTEGRATED SPEAKERS

LED BACKLIGHT

BUILT IN WIFI



my signage portal
SOFTWARE LICENSE
1 YEAR FREE
ONE YEAR FREE SOFTWARE SUBSCRIPTION

NARROW BEZEL

LANDSCAPE OR PORTRAIT ORIENTATION

INTEGRATED NETWORK ANDROID MEDIA PLAYER

Specification Table

| | | 43 Inch |
|---------------|---------------------------------|---|
| Panel | Resolution | 1920x1080 |
| | Display Area (mm) | 941.2x529.4 |
| | Aspect Ratio | 16:9 |
| | Brightness (cd/m ²) | 450 |
| | Colour | 16.7M |
| | Viewing Angle | 178° |
| | Contrast Ratio | 4000:1 |
| Audio | Speaker Type | 5W, 8Ω (x2) |
| AV Inputs | Video | HDMI, VGA |
| | Audio | Audio Socket (3.5mm) |
| Power | Power Consumption (W) | 45 |
| | Input Voltage | AC110~240V (50Hz~60Hz) |
| Mechanical | Unit Size (WxHxD mm) | 963.6x557.9x46.1 |
| | Package Size (WxHxD mm) | 1067x660x163 |
| | VESA Holes (mm) | 400x200 |
| | Net Weight (kg) | 11.25 |
| | Gross Weight (kg) | 15.2 |
| Environmental | Operating Temperature | 0 °C to 50 °C |
| | Storage Temperature | -30°C to 60°C |
| | Operating Humidity | 10% to 80% |
| | Storage Humidity | 5% to 95% |
| Computer | Media Formats | Video (MPG, AVI, MP4, RM, RMVB, TS), Audio (MP3, WMA), Image (JPG, GIF, BMP, PNG) |
| | Media Resolution | 1920x1080/1080x1920 |
| | Internal Memory | 6GB |
| | CPU | Quad-Core ARM Cortex A17, 1.6GHz |
| | GPU | Quad-Core ARM Mali-T764 |
| | RAM | 2GB DDR3 |
| | ROM | 8GB eMMC |
| | USB | 1 x USB (OTG/HOST), 1 x USB (HOST) |
| | LAN | 10/100M Ethernet |
| | Wi-Fi | 802.11b/g/n/ac |
| Accessories | OS | Android 7.1 |
| | Graphic Engine | OpenGL ES 1.1/2.0/3.0/3.1, OpenCL 1.1, Renderscript, Direct3D 11.1 |
| | Included | Scheduling Software, Remote Control, User Manual |
| Warranty | Optional | Wall Mount, Floor Stand/Trolley, Ceiling Mount, Table Stand |
| | Warranty Period | 3 Year Warranty |
| | Technical Support | Lifetime |

Errors and omissions excepted



Technical Drawing

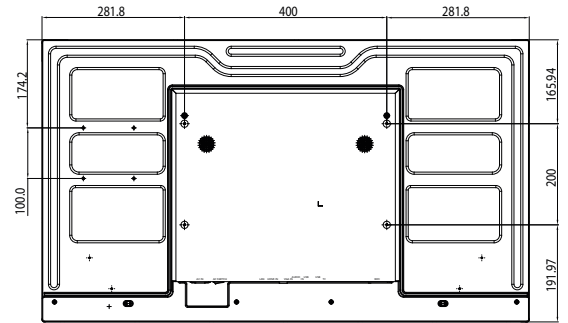
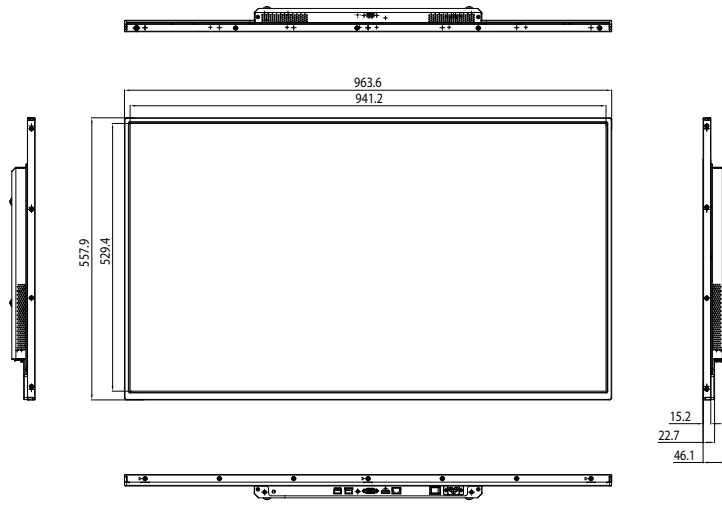

Why Choose Our Commercial Display Solutions?



Lifetime Technical Support

From the moment you receive your product, throughout the duration of your warranty and even after your warranty has expired we are here to support you. If you require any assistance setting up or using your product, or have any problems at all, we can provide free technical support via telephone and email.

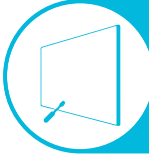

On-site Support and Maintenance*

If needed, we can provide an installation service for any of our products. We can also set up service-level agreements for larger projects that require maintenance contracts.



Extended Warranty*

All of our commercial display products come with a 3 year commercial warranty as standard but if you want to extend this you can upgrade this to cover a 5 year period at point of purchase.



Training

As well as providing free remote CMS training sessions and webinars we can also visit you to deliver bespoke training for our software and hardware*.



Advanced Replacements†

Should your display suffer from any kind of hardware failure during the warranty period we will send you an advanced replacement and arrange for your old display to be collected, free of charge. This ensures no downtime where you are without a screen.



Custom Product Testing & Configuration

If you need us to test third party software or a website, or configure your screen in a particular way before it is dispatched (e.g. in a particular orientation or network mode), we can do so to make your life easier.



3D Rendering

Want to know how a particular screen will look once installed? Send us a photo of the location and we will create a 3D rendering of any screen in situ to help you to visualise how amazing it will look.



Logistics Support

We hold more stock in our UK warehouse than any other manufacturer so we can help you meet tight deadlines. For last minute orders we can also offer special express or morning delivery options*. We also carry out UK based quality control checks on every display before it leaves our warehouse.



Project Support

If you need to loan a sample unit to test we'd be more than happy to arrange this. We can also provide a rental service for temporary projects*.



Customisation*

Your display can be customised to suit your requirements by adding your logo or printed graphics or even tailoring the colour of a display. We can also carry out hardware modifications to existing products or manufacture bespoke solutions for special projects.



Extras*

As well as being able to provide accessories and add-ons, such as extra remote controls, NUC PCs and video wall controllers, we can also supply custom made flight cases which are great if a display needs to be moved safely from place to place.

†UK mainland only

*These particular services may incur additional charges